

**MC1456**  
**MC1456C**  
**MC1556**

**INTERNALLY COMPENSATED, HIGH PERFORMANCE OPERATIONAL AMPLIFIER**

... designed for use as a summing amplifier, integrator, or amplifier with operating characteristics as a function of the external feedback components.

- Low Input Bias Current — 15 nA max
- Low Input Offset Current — 2.0 nA max
- Low Input Offset Voltage — 4.0 mV max
- Fast Slew Rate — 2.5 V/ $\mu$ s typ
- Large Power Bandwidth — 40 kHz typ
- Low Power Consumption — 45 mW max
- Offset Voltage Null Capability
- Output Short-Circuit Protection
- Input Over-Voltage Protection

**TYPICAL INPUT BIAS CURRENT AND INPUT OFFSET CURRENT versus TEMPERATURE for MC1556**

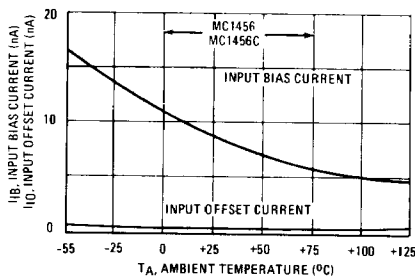

**REPRESENTATIVE CIRCUIT SCHEMATIC**

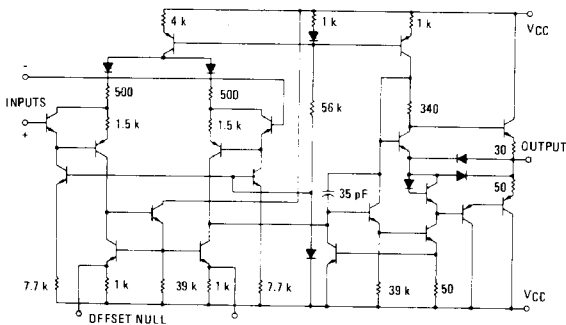

**OPERATIONAL AMPLIFIER**

SILICON MONOLITHIC INTEGRATED CIRCUIT

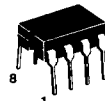
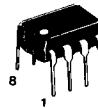
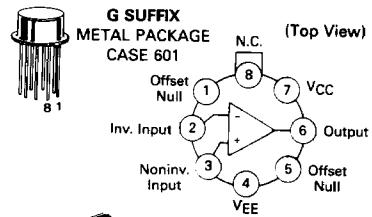

**P1 SUFFIX**  
 PLASTIC PACKAGE  
 CASE 626

**U SUFFIX**  
 CERAMIC PACKAGE  
 CASE 693

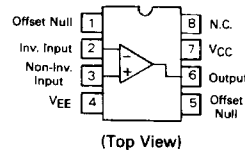

**ORDERING INFORMATION**

Device	Temperature Range	Package
MC1456G,CG MC1456CP1,P1	0°C to +70°C	Metal Can Plastic DIP
MC1556G MC1556U	-55°C to +125°C	Metal Can Ceramic DIP

**VOLTAGE-FOLLOWER PULSE RESPONSE**

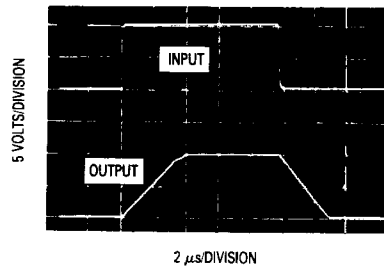

# MC1456, MC1456C, MC1556

## MAXIMUM RATINGS (T<sub>A</sub> = +25°C unless otherwise noted)

Rating	Symbol	MC1456		Unit
		MC1556	MC1456C	
Power Supply Voltage	V <sub>CC</sub> V <sub>EE</sub>	+22 -22	+18 -18	Vdc
Differential Input Voltage Range	V <sub>IDR</sub>	±V <sub>CC</sub>		Volts
Common-Mode Voltage Range	V <sub>ICR</sub>	±V <sub>CC</sub>		Volts
Load Current	I <sub>L</sub>	20		mA
Output Short Circuit Duration	t <sub>S</sub>	Continuous		
Power Dissipation (Package Limitation) Derate above T <sub>A</sub> = +25°C	P <sub>D</sub>	680 4.6		mW mW/°C
Operating Temperature Range	T <sub>A</sub>	-55 to +125	0 to +70	°C
Storage Temperature Range	T <sub>stg</sub>	-65 to +150	-65 to +150	°C

## ELECTRICAL CHARACTERISTICS (V<sub>CC</sub> = +15 Vdc, V<sub>EE</sub> = -15 Vdc, T<sub>A</sub> = +25°C unless otherwise noted).

Characteristic	Fig.	Symbol	MC1556			MC1456			MC1456C			Unit
			Min	Typ	Max	Min	Typ	Max	Min	Typ	Max	
Input Bias Current T <sub>A</sub> = +25°C T <sub>A</sub> = T <sub>low</sub> to T <sub>high</sub> (See Note 1)		I <sub>IB</sub>	-	8.0	15	-	15	30	-	15	90	nAdc
Input Offset Current T <sub>A</sub> = +25°C T <sub>A</sub> = +25°C to T <sub>high</sub> T <sub>A</sub> = T <sub>low</sub> to +25°C		I <sub>IO</sub>	-	1.0	2.0	-	5.0	10	-	5.0	30	nAdc
Input Offset Voltage T <sub>A</sub> = +25°C T <sub>A</sub> = T <sub>low</sub> to T <sub>high</sub>		V <sub>IO</sub>	-	2.0	4.0	-	5.0	10	-	5.0	12	mVdc
Differential Input Impedance (Open-Loop, f = 20 Hz) Parallel Input Resistance Parallel Input Capacitance		r <sub>p</sub> C <sub>p</sub>	-	5.0 6.0	-	-	3.0 6.0	-	-	3.0 6.0	-	Megohms pF
Common-Mode Input Impedance (f = 20 Hz)		z <sub>i</sub>	-	250	-	-	250	-	-	250	-	Megohms
Common-Mode Input Voltage Range	1	V <sub>ICR</sub>	±12	±13	-	+11	±12	-	±10.5	±12	-	V <sub>pk</sub>
Equivalent Input Noise Voltage (A <sub>V</sub> = 100, R <sub>S</sub> = 10 k ohms, f = 1.0 kHz, BW = 1.0 Hz)	2	e <sub>n</sub>	-	45	-	-	45	-	-	45	-	nV/(Hz) <sup>1/2</sup>
Common-Mode Rejection Ratio (f = 100 Hz)	3	CMRR	80	110	-	70	110	-	-	110	-	dB
Open-Loop Voltage Gain, (V <sub>O</sub> = ±10 V, R <sub>L</sub> = 2.0 k ohms) T <sub>A</sub> = +25°C T <sub>A</sub> = T <sub>low</sub> to T <sub>high</sub>	4,5,6	A <sub>VOL</sub>	100,000 40,000	200,000	-	70,000 40,000	100,000	-	25,000	100,000	-	V/V
Power Bandwidth (A <sub>V</sub> = 1, R <sub>L</sub> = 2.0 k ohms, THD ≤ 5%, V <sub>O</sub> = 20 Vp-p)	9	BWp	-	40	-	-	40	-	-	40	-	kHz
Unity Gain Crossover Frequency (open-loop)	5	BW	-	1.0	-	-	1.0	-	-	1.0	-	MHz
Phase Margin (open-loop, unity gain)	5,7		-	70	-	-	70	-	-	70	-	degrees
Gain Margin	5,7		-	18	-	-	18	-	-	18	-	dB
Slew Rate (Unity Gain)		SR	-	2.5	-	-	2.5	-	-	2.5	-	V/μs
Output Impedance (f = 20 Hz)		z <sub>o</sub>	-	1.0	2.0	-	1.0	2.5	-	1.0	-	kohms
Short-Circuit Output Current	8	I <sub>OS</sub>	-	-17, +9.0	-	-	-17, +9.0	-	-	-17, +9.0	-	mAde
Output Voltage Swing (R <sub>L</sub> = 2.0 k ohms)	10	V <sub>OR</sub>	±12	±13	-	+11	±12	-	±10	±12	-	V <sub>pk</sub>
Power Supply Rejection Ratio V <sub>CC</sub> = constant, R <sub>S</sub> ≤ 10 k ohms V <sub>EE</sub> = constant, R <sub>S</sub> ≤ 10 k ohms		PSRR+ PSRR-	-	50 50	100	-	75 75	200 200	-	75 75	-	μV/V
Power Supply Current		I <sub>CC</sub> I <sub>EE</sub>	-	1.0 1.0	1.5	-	1.3 1.3	3.0 3.0	-	1.3 1.3	4.0 4.0	mAde
DC Quiescent Power Dissipation (V <sub>O</sub> = 0)	11	P <sub>D</sub>	-	30	45	-	40	90	-	40	120	mW

Note 1: T<sub>low</sub>: 0° for MC1456 and MC1456C  
 -55°C for MC1556  
 T<sub>high</sub>: +70°C for MC1456 and MC1456C  
 +125°C for MC1556

# MC1456, MC1456C, MC1556

## TYPICAL CHARACTERISTICS

( $V_{CC} = +15\text{ Vdc}$ ,  $V_{EE} = -15\text{ Vdc}$ ,  $T_A = +25^\circ\text{C}$  unless otherwise noted).

**FIGURE 1 – INPUT COMMON-MODE SWING versus POWER SUPPLY VOLTAGE**

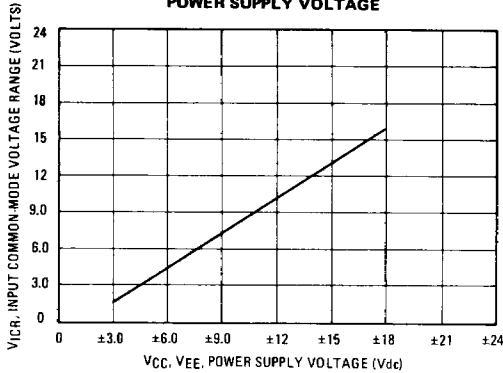

**FIGURE 2 – SPECTRAL NOISE DENSITY**

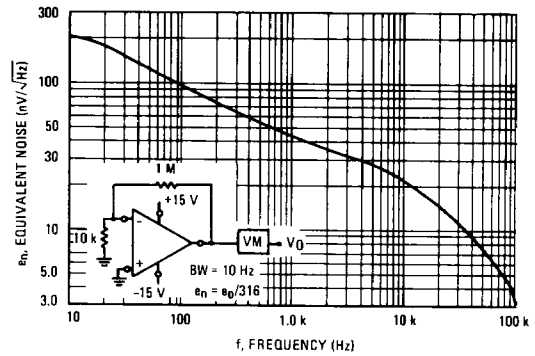

**FIGURE 3 – COMMON-MODE REJECTION RATIO versus FREQUENCY**

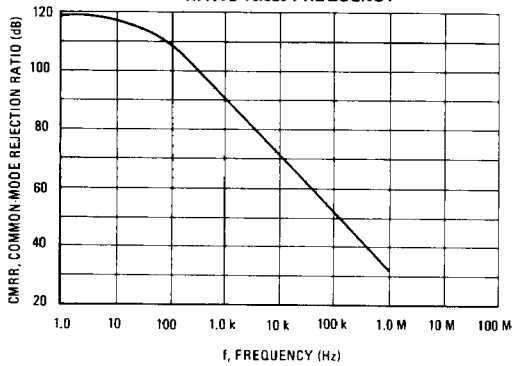

**FIGURE 4 – OPEN-LOOP VOLTAGE GAIN versus TEMPERATURE**

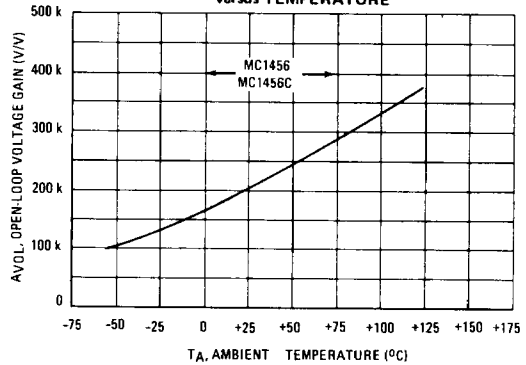

**FIGURE 5 – OPEN-LOOP FREQUENCY RESPONSE**

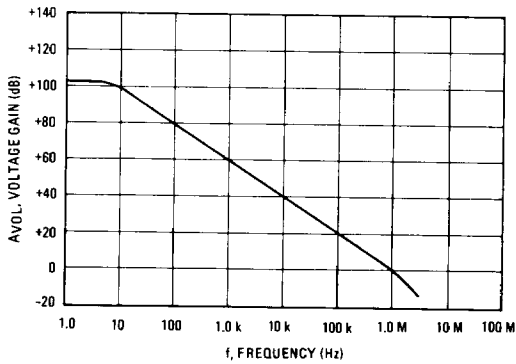

**FIGURE 6 – OPEN-LOOP VOLTAGE GAIN versus SUPPLY VOLTAGES**

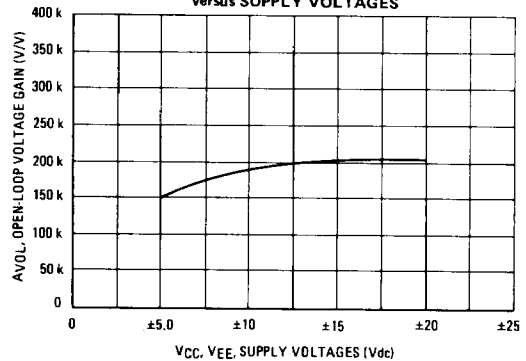

# MC1456, MC1456C, MC1556

## TYPICAL CHARACTERISTICS (continued)

FIGURE 7 – OPEN-LOOP PHASE SHIFT

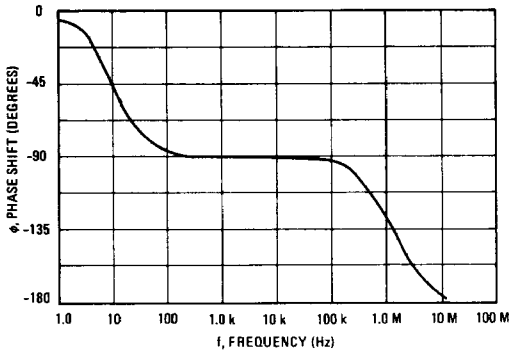

FIGURE 8 – OUTPUT SHORT-CIRCUIT CURRENT versus TEMPERATURE

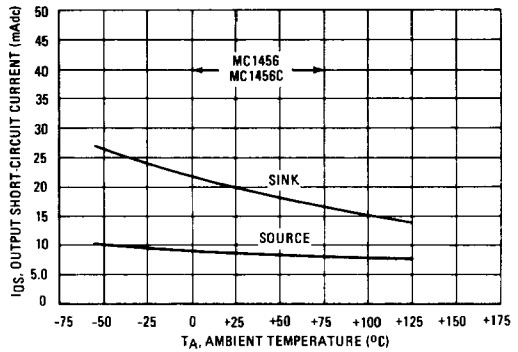

FIGURE 9 – POWER BANDWIDTH

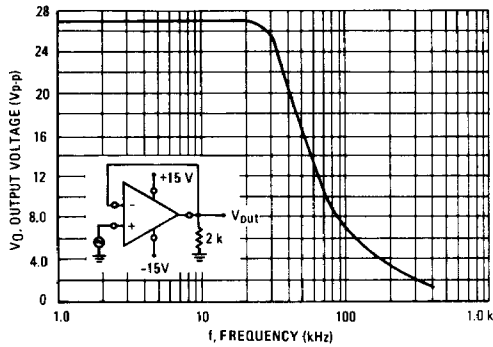

FIGURE 10 – OUTPUT VOLTAGE SWING versus LOAD RESISTANCE

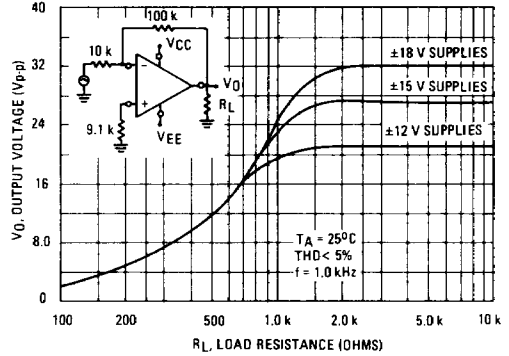
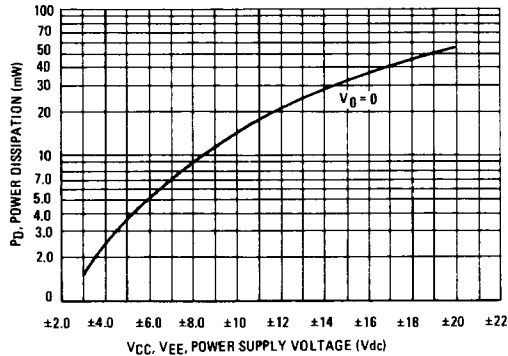

FIGURE 11 – POWER DISSIPATION versus POWER SUPPLY VOLTAGE



# MC1456, MC1456C, MC1556

## TYPICAL APPLICATIONS

Where values are not given for external components they must be selected by the designer to fit the requirements of the system.

FIGURE 12 — INVERTING FEEDBACK MODEL

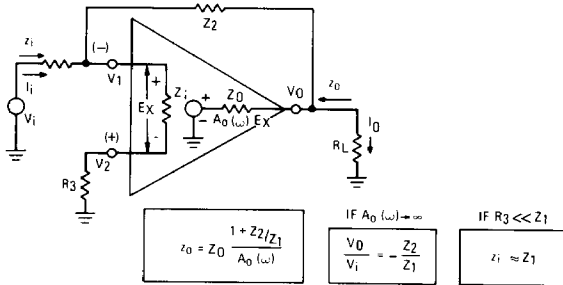

FIGURE 13 — NONINVERTING FEEDBACK MODEL

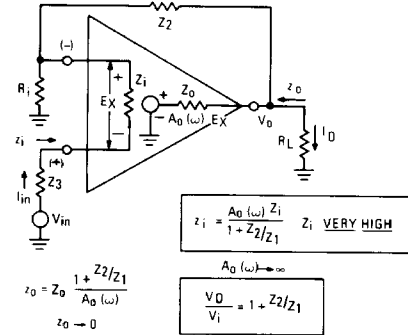

FIGURE 14 — LOW-DRIFT SAMPLE AND HOLD

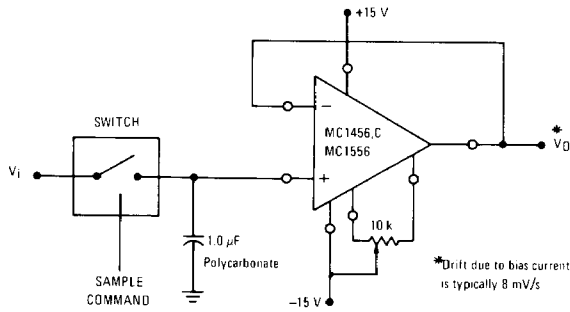
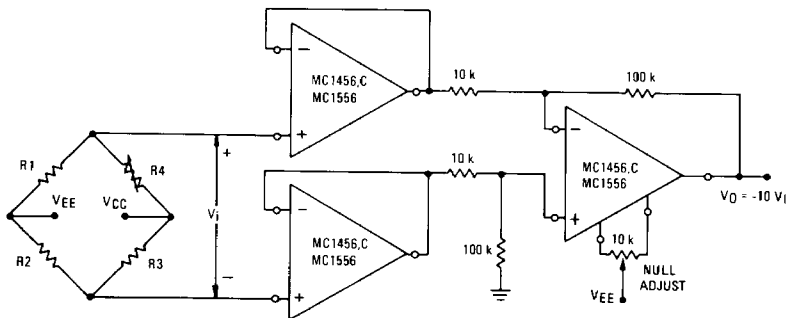

FIGURE 15 — HIGH IMPEDANCE BRIDGE AMPLIFIER



TYPICAL APPLICATIONS (continued)

FIGURE 16 – LOGARITHMIC AMPLIFIER

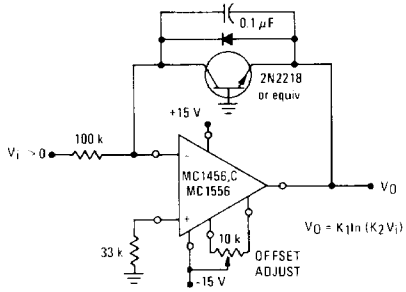

FIGURE 17 – VOLTAGE OFFSET NULL CIRCUIT

